

CM95/ CM100 TRUE RMS FLEXIBLE CLAMP METER



INSTRUCTION MANUAL

1. SAFETY INFORMATION: Always read before proceeding.

⚠ REMEMBER: SAFETY IS NO ACCIDENT

These instructions contain both information and warnings that are necessary for the safe operation and maintenance of this product. It is recommended that you read the instructions carefully and ensure that the contents are fully understood. Failure to understand and to comply with the warnings and instructions can result in serious injury, damage or even death.

Particular attention should be paid to the Warnings, Precautions and Technical Specifications.

Please keep these instructions for future reference. Updated instructions and product information are available at: www.martindale-electric.co.uk

1.1 Meaning of Symbols and Markings

- ⚠ Caution - risk of danger & refer to instructions
- ⚠ Caution - risk of electric shock
- ☐ Equipment protected by double or reinforced insulation (Class II)
- ⊗ Do not apply around or remove from uninsulated hazardous live conductors, which may render electric shock, electric burn, or arc flash.
- CAT III (Measurement Category III) is applicable to test and measuring equipment connected to the distribution part of the building's low-voltage MAINS installation.
- CAT IV (Measurement Category IV) is applicable to test and measuring equipment connected at the source of the building's low-voltage MAINS installation.

For further information on measurement categories see page 14 or visit www.martindale-electric.co.uk/measurement_categories.php

1



ALWAYS READ THESE INSTRUCTIONS BEFORE PROCEEDING

Thank you for buying one of our products. For safety and a full understanding of its benefits please read this manual before use. Technical support is available from 01923 441717 and support@martindale-electric.co.uk

CONTENTS

1	Safety Information	1
1.1	Meaning of Symbols and Markings	1
1.2	Precautions	2
2	Introduction	4
2.1	Inspection	4
2.2	Description	4
2.3	Accessories	4
2.4	Battery Installation	4
3	Operation	5
3.1	General	5
3.2	Low Battery Indication	5
3.3	Description of Flexible Clamp Meter Elements	6
3.4	Description of Press Buttons	6
3.5	Description of LCD Symbols	7
3.6	Auto Power Off	7
3.7	Display Hold	8
3.8	Min/Max	8
3.9	Backlight	8
3.10	AC Current Measurements	8
3.11	Position Sensitivity	9
4	Maintenance	10
4.1	Battery Replacement	10
4.2	Calibration	10
4.3	Cleaning	11
4.4	Repair & Service	11
4.5	Storage Conditions	11
5	Warranty	12
	Measurement Categories Specifications	14



Equipment complies with relevant EU Directives



End of life disposal of this equipment should be in accordance with relevant EU Directives

1.2 Precautions

This product has been designed with your safety in mind, but please pay attention to the following warnings and cautions before use.

⚠ Warnings

In order to avoid the danger of electrical shock, it is important that proper safety measures are taken when working with voltages exceeding 30V AC rms, 42V AC peak or 60V DC.

Where applicable other safety measures such as the use of protective gloves, goggles etc. should be employed.

The flexible clamp meter must only be used by a skilled and competent person who is familiar with the relevant regulations, the safety risks involved and the consequent normal safe working practices, and under the conditions and for the purposes for which it has been constructed and specified.

Before each use the flexible clamp meter should be examined for damage, cracks, cuts or scratches. **Do not use** if damaged in any way.

The flexible sensor and meter to sensor cable have contrasting outer and inner insulation to allow damage to the sensor and cable to be easily identified. If the inner insulation can be seen, the flexible clamp meter must **not be used**.

2

Make sure the flexible clamp meter is dry, clean and free from dust, grease and moisture while in use to avoid the danger from electric shock due to surface leakage.

Measuring a current that exceeds the specified limits of the unit may damage the unit and may expose the operator to a shock hazard. Always check the unit's specified limits before use.

The flexible clamp meter must only be used on CAT IV installations up to 600V to earth and CAT III and CAT II installations up to 1000V to earth, and within the operating temperature and humidity range specified.

When working on uninsulated hazardous live installations, **always de-energise** the installation during application and removal of the flexible current sensor.

Do not use if the battery compartment cover is not fitted.

⚠ Cautions

Avoid severe mechanical shock or vibration and extreme temperature.

Avoid excessive stresses to the flexible sensor entry point at the sensor coupling and the cable entry points at the sensor coupling and meter.

To avoid possible corrosion from leaking batteries, remove the batteries when the unit is not in use for an extended period.

3. OPERATION

3.1 General

If the magnitude of the AC current being measured is unknown, but known to be within the maximum safe limits of the meter, set the range to maximum.

If the meter displays “ — OL — ” the measurement limits of the range have been exceeded.

3.2 Low Battery Indication

If the  symbol is displayed, the battery needs replacing as measurement accuracy can no longer be guaranteed (see section 4.1 Battery Replacement).

2. INTRODUCTION

2.1 Inspection

Examine the shipping carton for any sign of damage. Inspect the unit and any accessories for damage. If there is any damage then consult your distributor immediately.

2.2 Description

The CM95 and CM100 are AC current meters with a flexible current sensor. This makes them particularly suited to measuring currents in awkwardly shaped or positioned conductors where access by conventional clamp meters may prove difficult.

The CM95 measures true rms AC current up to 400A in 3 ranges and is fitted with a 10" flexible sensor.

The CM100 measures true rms AC current up to 3000A in 3 ranges and is fitted with an 18" flexible sensor.

Further functions are:

- ◆ Min/Max indication
- ◆ Display hold
- ◆ Auto power off
- ◆ Display backlight

2.3 Accessories

The CM95 and CM100 come with the following accessories:

- ◆ 2 x 1.5V AAA batteries
- ◆ Instructions



2.4 Battery Installation

Refer to section 4.1 (Battery Replacement) for the battery installation instructions.

3.3 Description of Flexible Clamp Meter Elements

1	Flexible current sensor
2	Sensor coupling
3	Rotary on/off and range switch
4	Hold button
5	MIN/MAX function button
6	Backlight button
7	Liquid crystal display

3.4 Description of Press Buttons

	Selects display hold
	Selects minimum/maximum function
	Turns on/off backlight

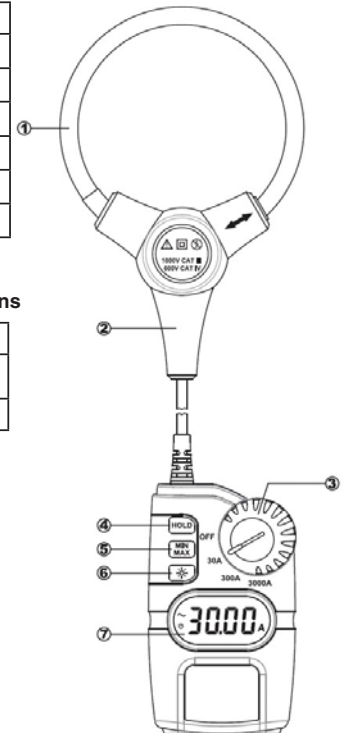

Figure 1

3.5 Description of LCD Symbols



MAX	The maximum reading is being displayed
MIN	The minimum reading is being displayed
HOLD	Display hold is activated
~	Indicates AC measurement
⊘	Auto power off is activated
A	Unit of measurement being displayed
🔋	Indicates low battery

3.6 Auto Power Off

If the flexible clamp meter is inactive for a period of 15 minutes it will automatically power off.

If any button is pressed after the clamp meter has automatically powered off, the clamp meter will turn back on.

To disable the auto power off function press **HOLD** at the same time as turning the rotary switch from **OFF** to any position.

The symbol will no longer be displayed on the LCD.

3.7 Display Hold

To hold a displayed value, press **HOLD**. The LCD will display **HOLD**.

To exit display hold, press **HOLD** again.

7

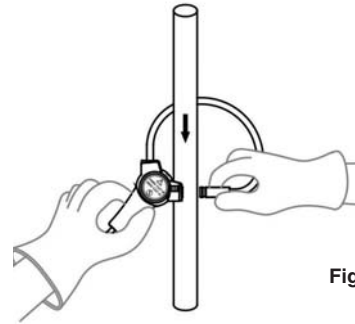

Figure 2

3.11 Position Sensitivity

If it is not possible to position the flexible sensor so the conductor is at the centre of the loop, the measured value will have additional errors dependant on the position of the conductor in the sensor loop. See figure 3 and the position sensitivity error table in the specification.

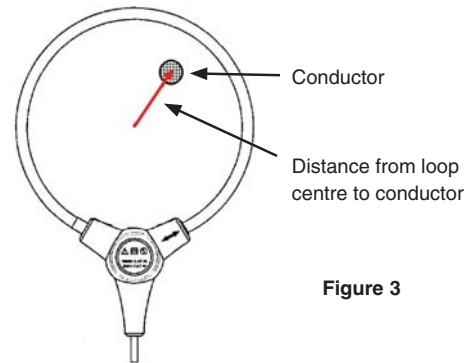

Figure 3

9

3.8 Min/Max

To display the maximum measured value press **MIN MAX**. The LCD will display **MAX**.

To display the minimum measured value press **MIN MAX** again. The LCD will display **MIN**.

Pressing **MIN MAX** for a third time will return the meter to a normal display mode with maximum and minimum measured values being stored. The LCD will display **MAX MIN** flashing.

To exit the Min/Max function, press **MIN MAX** for 2 seconds.

3.9 Backlight

To switch on the backlight press . Press again to turn the backlight off.

3.10 AC Current Measurements

Set the rotary switch to the required range.



Always de-energise an uninsulated hazardous live conductor under test before positioning the flexible current sensor around it.

Pull and unclip the flexible sensor from the sensor coupling at the end marked with .

Referring to figure 2, and taking all necessary safety precautions, wrap the flexible sensor around the conductor to be measured and clip the end of the flexible sensor back into the sensor coupling.

Position the flexible sensor so the conductor under test is at the centre of the sensor loop and perpendicular to the sensor loop.

Read the measured current from the display.

8

4. MAINTENANCE

4.1 Battery Replacement



To avoid shock or injury, disconnect the clamp meter from any external circuits and remove the test leads before proceeding.

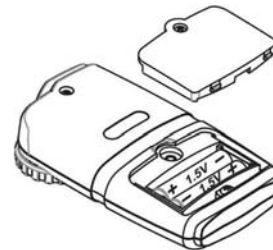

Figure 4

The battery compartment is underneath the unit.

To gain access, undo the screw securing the battery compartment cover, then lift off the cover.

Fit 2 new 1.5V AAA alkaline batteries (IEC LR03, NEDA 24A).

Replace the battery cover and the screw.

Note: Do not mix old and new batteries.

4.2 Calibration

To maintain the integrity of measurements made using your instrument, Martindale Electric recommends that it is returned at least once a year to an approved Calibration Laboratory for recalibration and certification.

Martindale Electric is pleased to offer you this service. Please contact our Service Department for details.

10

Email: service@martindale-electric.co.uk
 Tel: 01923 650660

4.3 Cleaning

 To reduce the risk of surface leakage, this instrument must be kept in a clean condition.

Prior to cleaning, ensure that the instrument is disconnected from any voltage source.

If contamination is found, clean with a damp soft cloth and if necessary a mild detergent or alcohol. Do not use abrasives, abrasive solvents, or detergents which can cause damage to the unit. If a mild detergent is used, the unit should subsequently be thoroughly cleaned with a water dampened soft cloth. After cleaning, dry and allow to remain in a dry environment for 2 hours before use.

4.4 Repair & Service

There are no user serviceable parts in this unit other than those that may be described in section 4. Return to Martindale Electric if faulty. Our service department will quote promptly to repair any fault that occurs outside the guarantee period.

Before the unit is returned, please ensure that you have checked the unit and batteries.

4.5 Storage Conditions

The instrument should be kept in warm dry conditions away from direct sources of heat or sunlight, and in such a manner as to preserve the working life of the unit. It is strongly advised that the unit is not kept in a tool box where other tools may damage it.

of this warranty is held invalid or unenforceable by a court or other decision-maker of competent jurisdiction, such holding will not affect the validity or enforceability of any other provision or other part of that provision.

Nothing in this statement reduces your statutory rights.

5. WARRANTY AND LIMITATION OF LIABILITY

This Martindale product is warranted to be free from defects in material and workmanship under normal use and service. The warranty period is 2 years and begins on the date of receipt by the end user. This warranty extends only to the original buyer or end-user customer, and does not apply to fuses, disposable batteries, test leads or to any product which, in Martindale's reasonable opinion, has been misused, altered, neglected, contaminated, or damaged by accident or abnormal conditions of operation, handling or storage.

Martindale authorised resellers shall extend this warranty on new and unused products to end-user customers only but have no authority to extend a greater or different warranty on behalf of Martindale.

Martindale's warranty obligation is limited, at Martindale's option, to refund of the purchase price, free of charge repair, or replacement of a defective product which is returned to Martindale within the warranty period.

This warranty is the buyer's sole and exclusive remedy and is in lieu of all other warranties, expressed or implied, including but not limited to any implied warranty of merchantability or fitness for a particular purpose. Martindale shall not be liable for any special, indirect, incidental or consequential damages or losses, including loss of data, arising from any cause or theory.

Since some jurisdictions do not allow limitation of the term of an implied warranty, or exclusion or limitation of incidental or consequential damages, the limitations and exclusions of this warranty may not apply to every buyer. If any part of any provision

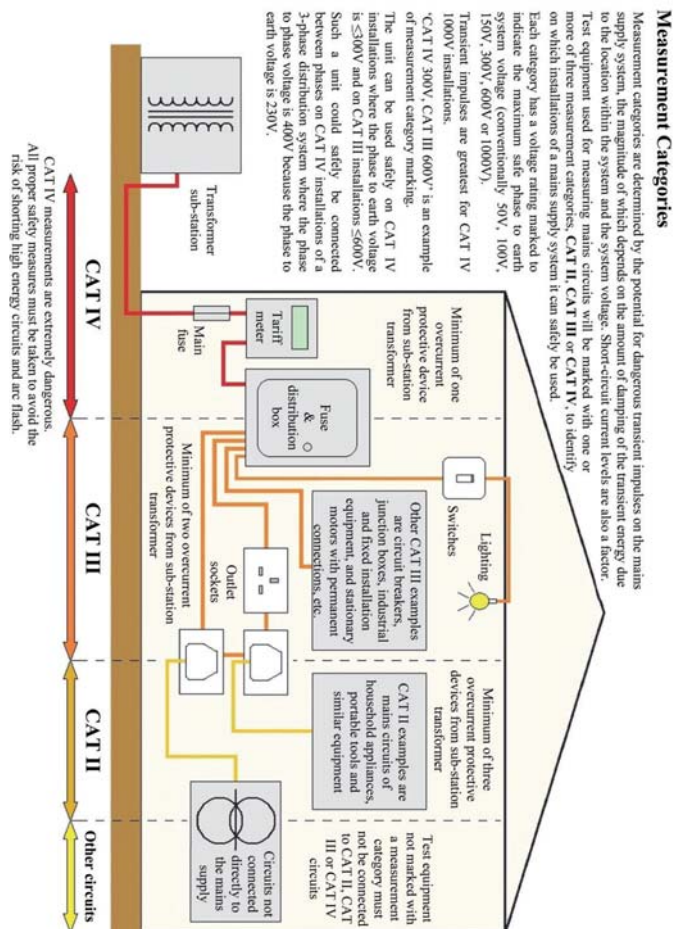



Specification
CM95/CM100
True RMS Flexible Clamp Meter



ELECTRICAL

All specified accuracies are at 23°C ± 5°C, <80% RH for 1 year.

Temperature coefficient: add 0.1 x (specified accuracy) per °C (0°C to 18°C, 28°C to 40°C)

Accuracies below are expressed as ± (percentage of reading + digits)

AC Current

CM95		
Range	Resolution	Accuracy (45Hz to 500Hz)
4A	0.001A	3.0% + 5 Note 1
40A	0.01A	
400A	0.1A	

CM100		
Range	Resolution	Accuracy (45Hz to 500Hz)
30A	0.01A	3.0% + 5 Note 1
300A	0.1A	
3000A	1A	



Specification
CM95/CM100
True RMS Flexible Clamp Meter

Dimensions: Meter: 120mm (L) x 70mm (W) x 26mm (D)

Cable length (probe to meter): 1.8m

Flexible sensor length: 254mm (CM95)

458mm (CM100)

Flexible sensor diameter: 5.5mm nominal (CM95)

8.5mm nominal (CM100)

Maximum conductor diameter: 85mm (CM95)

160mm (CM100)

Weight (including batteries): 196g approx. (CM95)

286g approx. (CM100)

Includes: 2 x 1.5V AAA batteries, instructions

ENVIRONMENTAL

Temperature & Humidity:

(Operating): 0°C to 50°C <80% R.H., non-condensing

(Storage): -10°C to 60°C < 70% R.H., batteries removed

Altitude: up to 2000m

Pollution degree: 2

SAFETY

Conforms to: BS EN 61010-1, BS EN 61010-2-032, CAT IV 600V, CAT III 1000 V Class II, double insulation

EMC

Conforms to BS EN 61326-1



Specification
CM95/CM100
True RMS Flexible Clamp Meter

AC conversion: True rms

True rms AC current accuracy is specified from 2% of range to 100% of range.

Crest factor: ≤ 1.6 at full scale
≤ 3.2 at half scale

Note 1: Measurement accuracy assumes a centrally positioned conductor, no external electrical or magnetic field and within operating temperature range. See figure 3 and the position sensitivity error table below for additional errors where the conductor is not centrally positioned.

Position Sensitivity Error		
Distance of conductor from loop centre	Additional Error (% of reading)	
	CM95	CM100
1" (2.54cm)	1.0	1.0
1.6" (4.06cm)	2.0	1.0
2" (5.1cm)	---	2.0
3" (7.6cm)	---	3.0

GENERAL

Display: Liquid crystal display with maximum reading 4200 (CM95), 3150 (CM100)

Sample rate: 2 times/sec

Overrange: " — OL — " is displayed

Power: 2 x 1.5V, AAA alkaline batteries (IEC LR03, NEDA 24A)

Battery life: 120 hours typical with alkaline

Low battery indication: symbol is displayed

Auto power off: After 15 minutes

Check out what else you can get from Martindale:

- 18th Edition Testers
- Accessories
- Calibration Equipment
- Continuity Testers
- Electricians' Kits
- Environmental Products
- Full Calibration & Repair Service
- Fuse Finders
- Digital Clamp Meters
- Digital Multimeters
- Labels
- Microwave Leakage Detectors
- Motor Maintenance Equipment
- Multifunction Testers
- Non-trip Loop Testers
- Pat Testers & Accessories
- Phase Rotation Testers
- Proving Units
- Socket Testers
- Thermometers & Probes
- Test Leads
- Voltage Indicators
- Specialist Metrohm Testers (4 & 5kV)
- Specialist Drummond Testers



Martindale Electric Company Limited
Metrohm House, Imperial Park, Imperial Way, Watford,
Hertfordshire, WD24 4PP, UK

Tel: +44 (0)1923 441717 Fax: +44 (0)1923 446900

E-mail: sales@martindale-electric.co.uk

Website: www.martindale-electric.co.uk



© 2015 Martindale Electric Company Ltd.
Registered in England No. 3387451. Rev1 LITCM95/CM100