

MM64 MULTIMETER

Instruction Manual



MARTINDALE
● ● ● ELECTRIC

Keeping You Safe



GENERAL SAFETY INFORMATION: Always read before proceeding.

Warning

These instructions contain both information and warnings that are necessary for the safe operation and maintenance of this product. It is recommended that you read the instructions carefully and ensure that the contents are fully understood. Failure to understand and to comply with the warnings and instructions can result in serious injury, damage or even death.

In order to avoid the danger of electrical shock, it is important that proper safety measures are taken when working with voltages exceeding the extra low voltage (ELV) limit of 50V (25V) RMS AC or 120V (60V) DC. The values in brackets apply to restricted voltage ranges (for example in the medical or agricultural sector).

This product must only be used by a competent person capable of interpreting the results under the conditions and for the purposes for which it has been constructed. Particular attention should be paid to the Warnings, Precautions and Technical Specifications. Always check the unit is in good working order before use and that there are no signs of damage to it. Do not use if damaged.

Where applicable other safety measures such as use of protective gloves, goggles etc. should be employed.

Please keep these instructions for future reference. Updated instructions and product information are available at: www.martindale-electric.co.uk

REMEMBER: SAFETY IS NO ACCIDENT

MEANING OF SYMBOLS:



Caution - risk of danger & refer to instructions



Caution - risk of electric shock



Equipment protected by double or reinforced insulation (Class II)

ELV

Extra low voltage. Voltage below 50V (25V) RMS AC or 120V (60V) DC



Equipment complies with relevant Directives



Equipment complies with relevant UK conformity



Direct current (DC)



Alternating current (AC)



Earth (ground)



End of life disposal of this equipment should be in accordance with relevant directives

Thank you for using one of our products. For safety and full understanding of its benefits please read this manual before use. Technical support is available from +44 (0)1923 441717 and support@martindale-electric.co.uk.

CONTENTS

1	Introduction	1
1.1	Inspection	1
1.2	Description	1
1.3	Accessories	1
1.3	Battery Installation	1
2	Product Specific Safety Information	2
2.1	Precautions	2
3	Operation	4
3.1	General	4
3.2	Low Battery Indication	4
3.3	Description of Terminals	4
3.4	Description of Press Buttons	4
3.5	Description of LCD Symbols	5
3.6	Max / Min	5
3.7	Backlight	5
3.8	Voltage Measurement	5
3.9	Current Measurement	5
3.10	Resistance Measurement	6
3.11	Capacitance Measurement	6
3.12	Frequency Measurement	6
3.13	Temperature Measurement	7
3.14	Temperature Offset Adjustment	7
3.15	Continuity Testing	7
3.16	Diode Testing	8
4	Maintenance	8
4.1	Battery Replacement	8
4.2	Fuse Replacement	9
4.3	Test Lead Replacement	9
4.4	Calibration	9
4.5	Cleaning	10
4.6	Repair & Service	10
4.7	Storage Conditions	10
5	Warranty Specifications	10

1. INTRODUCTION

1.1 Inspection

Examine the shipping carton for any sign of damage. Inspect the unit and any accessories for damage. If there is any damage then consult your distributor immediately.

1.2 Description

The MM64 is a 3½ digit multimeter with the following functions:

- AC & DC voltage to 600V
- AC & DC current to 200mA
- Resistance to 20MΩ
- Capacitance to 20mF
- Frequency to 40kHz
- Temperature to 750°C/1400°F using Type-K thermocouple
- Continuity with audible indication
- Diode testing

Further functions are:

- Max / Min indication
- Display backlight
- Auto power off

1.3 Accessories (included)

- TL16 test leads
- Type K thermocouple
- Spare 0.25A / 500V, fast acting ceramic fuse
- 9V battery (installed)
- Instructions

1.4 Battery Installation

Refer to Section 4.1 (Battery Replacement) for the battery installation instructions for the MM64.

2. PRODUCT SPECIFIC SAFETY INFORMATION

Measurement Category III (CAT III) is applicable to test and measuring equipment connected to the distribution part of the building's low-voltage MAINS installation.

Measurement Category IV (CAT IV) is applicable to test and measuring equipment connected at the source of the building's low-voltage MAINS installation.

2.1 Precautions

This product has been designed with your safety in mind, but please pay attention to the following warnings and cautions before use.

Warning

Before use check the unit for cracks or any other damage. Make sure the unit is free from dust, grease and moisture. Also check any associated leads and accessories for damage. Do not use if damaged.

Warning

Do not use if the battery / fuse cover is not fitted.

Warning

When this unit is used in combination with test leads, the measurement category of the combination is the lower measurement category of either this unit or the test leads used. Likewise, if test lead accessories such as crocodile clips are also used, the measurement category will be the lowest measurement category in that combination.

 **Warning**

Always test this unit on an appropriate proving device or known voltage source before and after using it to determine if a hazardous voltage exists in a circuit to be tested.

 **Warning**

When using test leads, always keep your fingers behind the finger guard on the test lead probe.

 **Warning**

Measuring a voltage that exceeds the specified limits of the unit may damage the unit and expose the operator to a shock hazard. Always check the unit's specified limits before use.

 **Warning**

In order to avoid the danger of electrical shock, it is important that proper safety measures are taken when working with voltages exceeding the extra low voltage (ELV) limit of 50V (25V) RMS AC or 120V (60V) DC. The values in brackets apply to restricted voltage ranges (for example in the medical or agricultural sector).

 **Caution**

To avoid burns or damage to equipment, do not take temperature measurements inside microwave ovens.

 **Caution**

Avoid severe mechanical shock or vibration and extreme temperature.

3. OPERATION

3.1 General

If the multimeter does not measure current the internal fuse (F1) may have blown (see section 4.2 Fuse Replacement).

If the multimeter does not measure capacitance the internal fuse (F2) may have blown (see section 4.2 Fuse Replacement).

If the magnitude of a parameter to be measured is unknown, but known to be within the maximum safe limits of the multimeter, then manually set the range to maximum. For example, if measuring DC voltage and the voltage magnitude is unknown, set the range to 600V, then if required reduce the range for a satisfactory reading.

If the multimeter displays OL or -OL then the measurement limits of the range have been exceeded.

3.2 Low Battery Indication

If the  symbol is displayed then the battery needs replacing (see section 4.1 Battery Replacement).

3.3 Description of Terminals

F	Input terminal for capacitance measurements
mA	Input terminal for AC & DC current measurements
COM	Common terminal for all measurements
VΩ	Input terminal for AC & DC voltage, resistance continuity, diode and frequency measurements
TYPE K	Input terminals for Type K thermocouple

3.4 Description of Press Buttons

MAX/MIN Selects maximum / minimum function



Turns on/off the backlight

3.5 Description of LCD Symbols

MAX	Maximum indication is selected
MIN	Minimum indication is selected
kHz	Unit of frequency measurement being displayed
	Indicates battery is low

3.6 Max / Min

To select the Max / Min function press the Max / Min button.

Alternate between displaying the maximum and minimum measured values by pressing the Max/Min button.

To exit the Max / Min function hold down the Max / Min button for 2 seconds.

3.7 Backlight

Press the  button to turn on/off the backlight.

The backlight will automatically turn off after approx 4½ minutes.

3.8 Voltage Measurement

Connect the black test lead to the COM terminal and the red test lead to the VΩ terminal.

Set the rotary switch to either AC V or DC V and the required range.

Taking all necessary safety precautions connect the test leads to the circuit being measured and read the measured voltage from the display.

3.9 Current Measurement

Connect the black test lead to the COM terminal and the red test lead to the mA terminal. Set the rotary switch to either AC A or DC A and the required range.

Taking all necessary safety precautions connect the test leads in series with the circuit being measured and read the measured current from the display.

3.10 Resistance Measurement

Connect the black test lead to the COM terminal and the red test lead to the V Ω terminal.

Set the rotary switch to Ω and the required range.

Taking all necessary safety precautions connect the test leads to the circuit being measured and read the measured resistance from the display.

3.11 Capacitance Measurement



Be sure the capacitor being tested is completely discharged before connecting any test leads.

Connect the black test lead to the COM terminal and the red test lead to the F terminal.

Set the rotary switch to F and the required range.

Taking all necessary safety precautions, and observing the correct polarity for electrolytic capacitors, connect the test probes to the capacitor to be measured and read the measured capacitance from the display.

3.12 Frequency Measurement

Connect the black test lead to the COM terminal and the red test lead to the V Ω terminal.

Set the rotary switch to 40kHz.

Taking all necessary safety precautions connect the test leads to the circuit being measured and read the measured frequency from the display.

3.13 Temperature Measurement

Connect a Type K thermocouple probe to the TYPE K socket.

Set the rotary switch to °C or °F and the required range.

Taking all necessary safety precautions position the thermocouple at the surface to be measured and read the measured temperature from the display.

Note: Repeated flexing can break the thermocouple leads. To prolong lead life, avoid sharp bends in the leads, especially near the connector.

3.14 Temperature Offset Adjustment

The TEMP OFFSET is set at the factory. The TEMP OFFSET may be adjusted to optimise measurement accuracy for an individual Type K thermocouple at a chosen temperature.

3.15 Continuity Testing

Connect the black test lead to the COM terminal and the red test lead to the V Ω terminal.

Set the rotary switch to ●)))

Taking all necessary safety precautions connect the test leads to the circuit being tested.

The buzzer will sound if the resistance is $<100\Omega$.

3.16 Diode Testing

If the diode to be tested is in circuit, be sure the circuit power is switched off.

Connect the black test lead to the COM terminal and the red test lead to the $V\Omega$ terminal.

Set the rotary switch to  .

Taking all necessary safety precautions connect the test leads to the diode being tested.

If the diode is good a forward bias will give a display reading of around 0.6V (silicon diode) and a reverse bias will give a display of OL. If the diode is shorted or open circuit the display will indicate approx 0V or OL respectively for both forward and reverse bias.

4. MAINTENANCE

Battery Replacement

 To avoid shock or injury, disconnect the multimeter from any external circuits or components and remove the test leads before proceeding.

Replace the battery by removing the two screws from the battery cover and lifting the battery cover.

Fit a new 9V, NEDA 1604, JIS006P, IEC 6F22 battery and replace the battery cover and screws.

4.2 Fuse Replacement

 To avoid shock, injury or damage to the multimeter, disconnect the multimeter from any external circuits or components and remove the test leads before proceeding.

 Replace only with the fuse specified.

Replace the fuses by removing the three screws securing the rear casing, and lift off the rear casing.

Replace F1 or F2 only with the original type 0.25A / 500V, fast acting ceramic fuse.

Replace the rear casing and screws.

4.3 Test Lead Replacement

If the test leads become damaged they should be replaced.

 The replacement test leads must have the same (or better) overvoltage category rating as the TL16 leads supplied

4.1 Calibration

To maintain the integrity of measurements made using your instrument, Martindale Electric recommends that it is returned at least once a year to an approved Calibration Laboratory for recalibration and certification.

Martindale Electric is pleased to offer you this service. Please contact our Service Department for details.

Email: service@martindale-electric.co.uk

Tel: +44 (0)1923 650660

4.5 Cleaning



To reduce the risk of surface leakage, this instrument must be kept in a clean condition.

Prior to cleaning, ensure that the instrument is disconnected from any voltage source.

If contamination is found, clean with a damp soft cloth and if necessary, a mild detergent. Do not use abrasives, abrasive solvents, or detergents which can cause damage to the unit. If a mild detergent is used, the unit should subsequently be thoroughly cleaned with a water dampened soft cloth. After cleaning, dry and allow to remain in a dry environment for 2 hours before use.

4.6 Repair & Service

There are no user serviceable parts in this unit other than those that may be described in section 3. Return to Martindale Electric if faulty. Our service department will quote promptly to repair any fault that occurs outside the guarantee period.

Before the unit is returned, please ensure that you have checked the unit, batteries, fuses, poor connections and leads.

4.7 Storage Conditions

The instrument should be kept in warm dry conditions away from direct sources of heat or sunlight, and in such a manner as to preserve the working life of the unit. It is strongly advised that the unit is not kept in a tool box where other tools may damage it

5. WARRANTY AND LIMITATION OF LIABILITY

This Martindale product is warranted to be free from defects in material and workmanship under normal use and service. The warranty period is 2 years and begins on the date of receipt by the

end user. This warranty extends only to the original buyer or end-user customer, and does not apply to fuses, disposable batteries, test leads or to any product which, in Martindale's reasonable opinion, has been misused, altered, neglected, contaminated, or damaged by accident or abnormal conditions of operation, handling or storage.

Martindale authorised resellers shall extend this warranty on new and unused products to end-user customers only but have no authority to extend a greater or different warranty on behalf of Martindale.

Martindale's warranty obligation is limited, at Martindale's option, to refund of the purchase price, free of charge repair, or replacement of a defective product which is returned to Martindale within the warranty period.

This warranty is the buyer's sole and exclusive remedy and is in lieu of all other warranties, expressed or implied, including but not limited to any implied warranty of merchantability or fitness for a particular purpose. Martindale shall not be liable for any special, indirect, incidental or consequential damages or losses, including loss of data, arising from any cause or theory.

Since some jurisdictions do not allow limitation of the term of an implied warranty, or exclusion or limitation of incidental or consequential damages, the limitations and exclusions of this warranty may not apply to every buyer. If any part of any provision of this warranty is held invalid or unenforceable by a court or other decision-maker of competent jurisdiction, such holding will not affect the validity or enforceability of any other provision or other part of that provision.

Nothing in this statement reduces your statutory rights.

MEASUREMENT CATEGORIES

CAT Ratings

BS EN61010-1 Installation

Categories (CAT ratings) define the risks from hazardous transient impulses and potentially lethal short circuit currents on the mains supply system based on where you are working.

Voltage Ratings

Test equipment used for measuring mains circuits will have a CAT rating to show where it can be used. Each category also has a voltage rating to show the maximum safe phase to earth system voltage, normally 50V, 100V, 150V, 300V, 600V or 1000V.

Stay safe - Match your test equipment safety rating to the installation category.

CAT II: Socket outlets and similar points of the mains installation.

CAT III: The distribution part of the building's mains installation.

CAT IV: The supply side source of the building's mains installation.

Testers, leads and accessories all need safety ratings equivalent to, or higher than the installation category and voltage rating for the location to be safe.

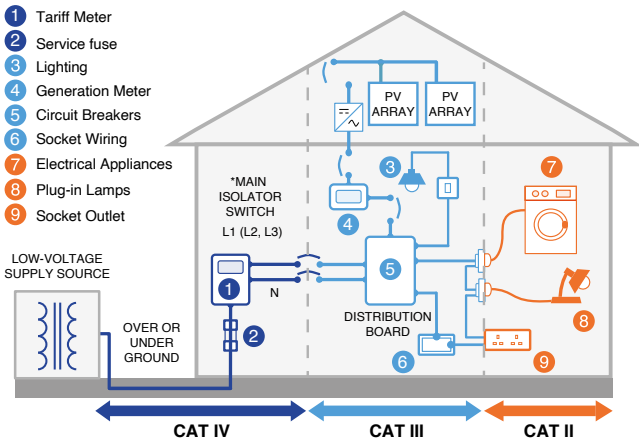



ELECTRICAL

All specified accuracies are at $23^{\circ}\text{C} \pm 5^{\circ}\text{C}$, $<75\%$ RH for 1 year.

Temperature coefficient: 0.1 x (specified accuracy) per $^{\circ}\text{C}$ (0°C to 18°C , 28°C to 50°C)

DC VOLTAGE

Ranges: 200mV, 2000mV, 20V, 200V, 600V

Resolution: 200mV, 2000mV, 20V, 200V, 600V

Accuracy: $\pm (0.5\%$ of rdg + 1 dgt)

Input impedance: $10\text{M}\Omega$

Overload protection: 600V DC or AC rms
600V DC or AC rms for 15 seconds on 200 mV range

AC VOLTAGE (50Hz to 500Hz)

Ranges: 200mV, 2000mV, 20V, 200V, 600V

Resolution: 0.1mV, 0.001V, 0.01V, 0.1V, 1V

Accuracy: 200mV to 20V ranges $\pm (1.2\%$ of rdg + 4 dgts)

200V to 600V range $\pm (2.0\%$ of rdg + 4 dgts)

Input impedance: $10\text{M}\Omega$

Overload protection: 600V DC or AC rms. 600V DC or AC rms for 15 seconds on 200mV range

DC CURRENT

Ranges: $200\mu\text{A}$, 20mA, 200mA

Resolution: $0.1\mu\text{A}$, 0.01mA, 0.1mA

Accuracy: $\pm (1.0\%$ of rdg + 1 dgt)

Input protection: 0.25A/500V fast blow ceramic fuse



Keeping You Safe

Specification

MM64

Digital Multimeter

AC CURRENT (50Hz to 500 Hz)

Ranges: 200 μ A, 20mA, 200mA

Resolution: 0.1 μ A, 0.01mA, 0.1mA

Accuracy: \pm (1.5% of rdg + 4 dgts)

Input protection: 0.25A/500V fast blow ceramic fuse

RESISTANCE

Ranges: 200 Ω , 2k Ω , 200k Ω , 20M Ω

Resolution: 0.1 Ω , 0.001k Ω , 0.1k Ω , 0.01M Ω

Accuracy: 200 Ω to 200k Ω ranges \pm (1.0% of rdg + 4 dgts)

20M Ω range \pm (2.0% of rdg + 4 dgts)

Open circuit voltage: 0.3V DC (3.0V DC on 200 Ω range)

Overload protection: 500V DC or AC rms

CAPACITANCE

Ranges: 200 μ F, 2mF, 20mF

Resolution: 0.1 μ F, 0.001mF, 0.01mF

Accuracy: \pm (4.0% of rdg + 10 dgts)

Test frequency: 21Hz

Test voltage: < 3.0V

Input protection: 0.25A/500V fast blow ceramic fuse

FREQUENCY (Autoranging)

Ranges: 2kHz, 20kHz, 40kHz

Resolution: 0.001kHz, 0.01 kHz, 0.1kHz

Accuracy: \pm (0.1% of rdg + 3 dgts)

Minimum input: 10Hz

Input sensitivity: 3.5V rms minimum

Overload protection: 500V DC or AC rms



Keeping You Safe

Specification

MM64

Digital Multimeter

TEMPERATURE

Sensor type: type K thermocouple

Range	Resolution	Accuracy
200 °C	0.1 °C	-35 °C to 0 °C ± (3.0 % rdg + 3 °C)
750 °C	1 °C	0 °C to 200 °C ± (1.0 % rdg + 1 °C)
		200 °C to 750 °C ± (3.0 % rdg + 3 °C)
200 °F	0.1 °F	-30 °F to 32 °F ± (3.0 % rdg + 6 °F)
1400 °F	1 °F	32 ° to 400 °F ± (1.0 % rdg + 2 °F)
		400 °F to 1400 °F ± (3.0 % rdg + 6 °F)

Overload protection: 60V DC or 30V AC rms

CONTINUITY

Audible indication: less than 100Ω

Response time: 100ms

Overload protection: 500V DC or AC rms

DIODE TEST

Test current: 1.0mA approx

Accuracy: ± (1.5% rdg + 3 dgts)

Open circuit voltage: 3.0V DC typical

Overload protection: 500V DC or AC rms



Keeping You Safe

Specification

MM64

Digital Multimeter

GENERAL

Display: 3½ digit liquid crystal display with a maximum reading of 1999

Polarity: automatic, positive implied, negative polarity indication

Overrange: (OL) or (-OL) is displayed

Zero: Automatic

Low battery indication:  symbol is displayed when the battery voltage drops below the operating level

Measurement rate: 2.5 times per second, nominal

Auto power off: after approx 25 minutes

Operating environment: 0°C to 50°C at < 70% RH

Storage temperature: -20°C to 60°C at < 80% RH

Altitude: Up to 2000m

Power: Single standard 9 volt battery, NEDA 1604, JIS006P, IEC 6F22

Battery life: 150 hours typical with carbon-zinc

Dimensions: 165mm (H) x 78mm (W) x 42.5mm (D)

Weight: Approx. 285g

Includes: TL16 test leads, Type K thermocouple, 1 x spare fuse, 9V battery (installed) and instructions

SAFETY

Conforms to BS EN 61010-1, CAT III 600 V

Class II Double Insulation

Pollution degree: 2 for indoor use

TL16 test leads conform to BS EN 61010-031 CAT III 1000V, CAT IV 600V, 10A

EMC: Conforms to BS EN 61326-1

Check out what else you can get from Martindale:

- 18th Edition Testers
- Accessories
- Cable Locators
- Calibration Equipment
- Continuity Testers
- Digital Clamp Meters
- Digital Multimeters
- Electricians' Kits
- Environmental Products
- Full Calibration & Repair Service
- Fuse Finders
- Labels
- Microwave Leakage Detectors
- Multifunction Testers
- PAT Testers & Accessories
- Phase Rotation Testers
- Proving Units
- Safe Isolation Kits
- Socket Testers
- Specialist Drummond Testers
- Thermometers & Probes
- Test Leads
- Voltage Indicators

Drummond products by Martindale Electric Co. Ltd. Metrohm House,
12 Imperial Park, Imperial Way, Watford WD24 4PP. T: +44 (0)1923 441717
www.martindale-electric.co.uk sales@martindale-electric.co.uk

Ver. F1.0

Due to policy of continuous development, Martindale Electric reserves the right to alter equipment specification and description outlined in this document without prior notice. No part of this document shall be deemed to be part of any contract for the equipment unless specifically referred to as an inclusion within such contract. © 2025 Martindale Electric Co. Ltd. Registered in England No. 3387451. LITMM64